

Activities

Monday 11th May

Mindful
colouring
in



Tuesday 12th May

Nature
scavenger
hunt



Wednesday 13th May

I spy sheet



Thursday 14th May

Imaginative play - build
a zoo. Hide the paw
prints outside, enter
using your ticket and
mark off when you find
the prints.



Friday 15th May

Design your own
T-Shirt and share
your designs with
us via text or
Facebook



Saturday 16th May

Create a nature
mandala using
leaves, sticks,
rocks, etc. Share
your photos



Sunday 17th May

How to
draw
sheet



Dance
like no
one is
watching!

*Remember we are just
a call/message away if
you need anything.
0428 736 961*

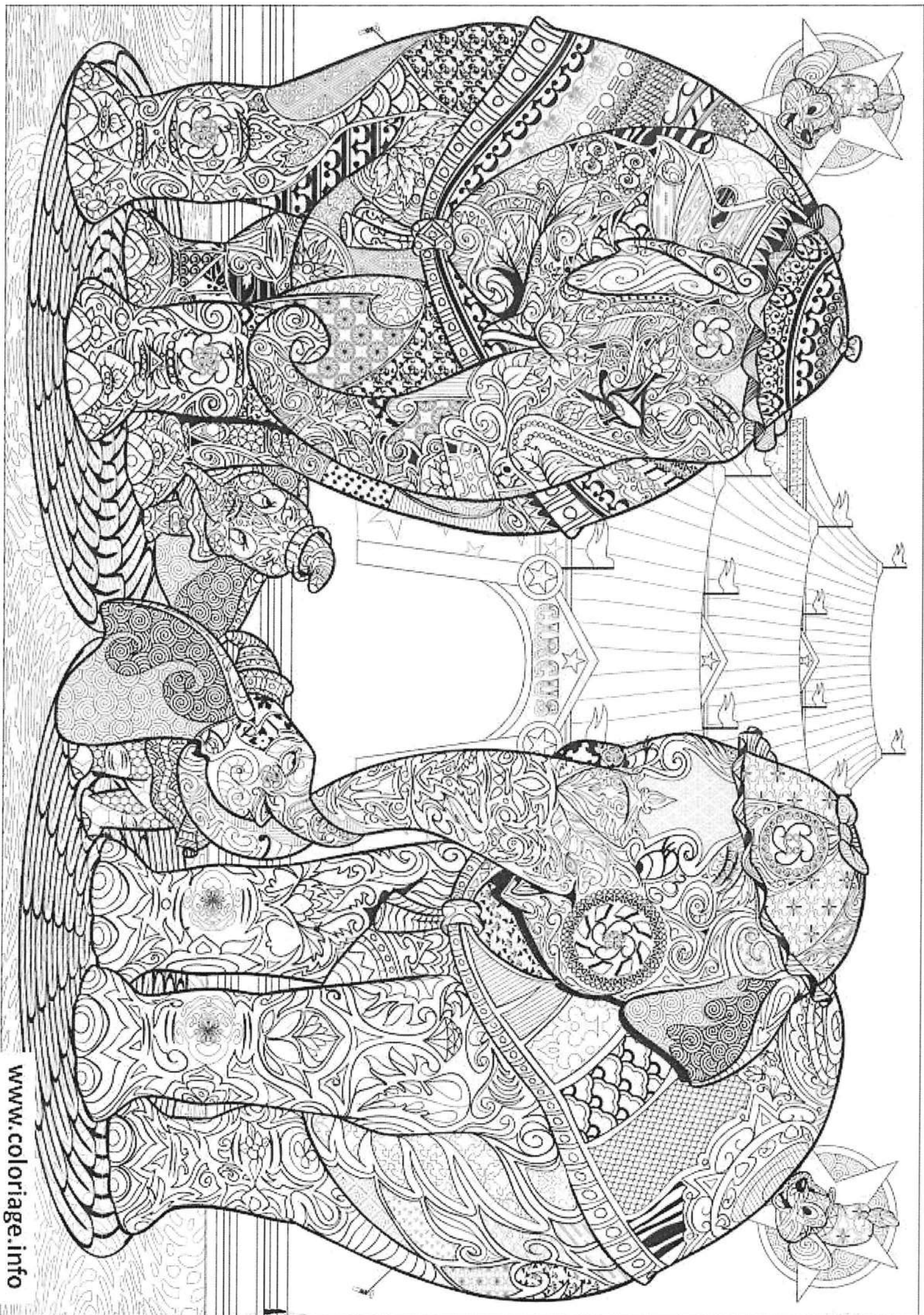





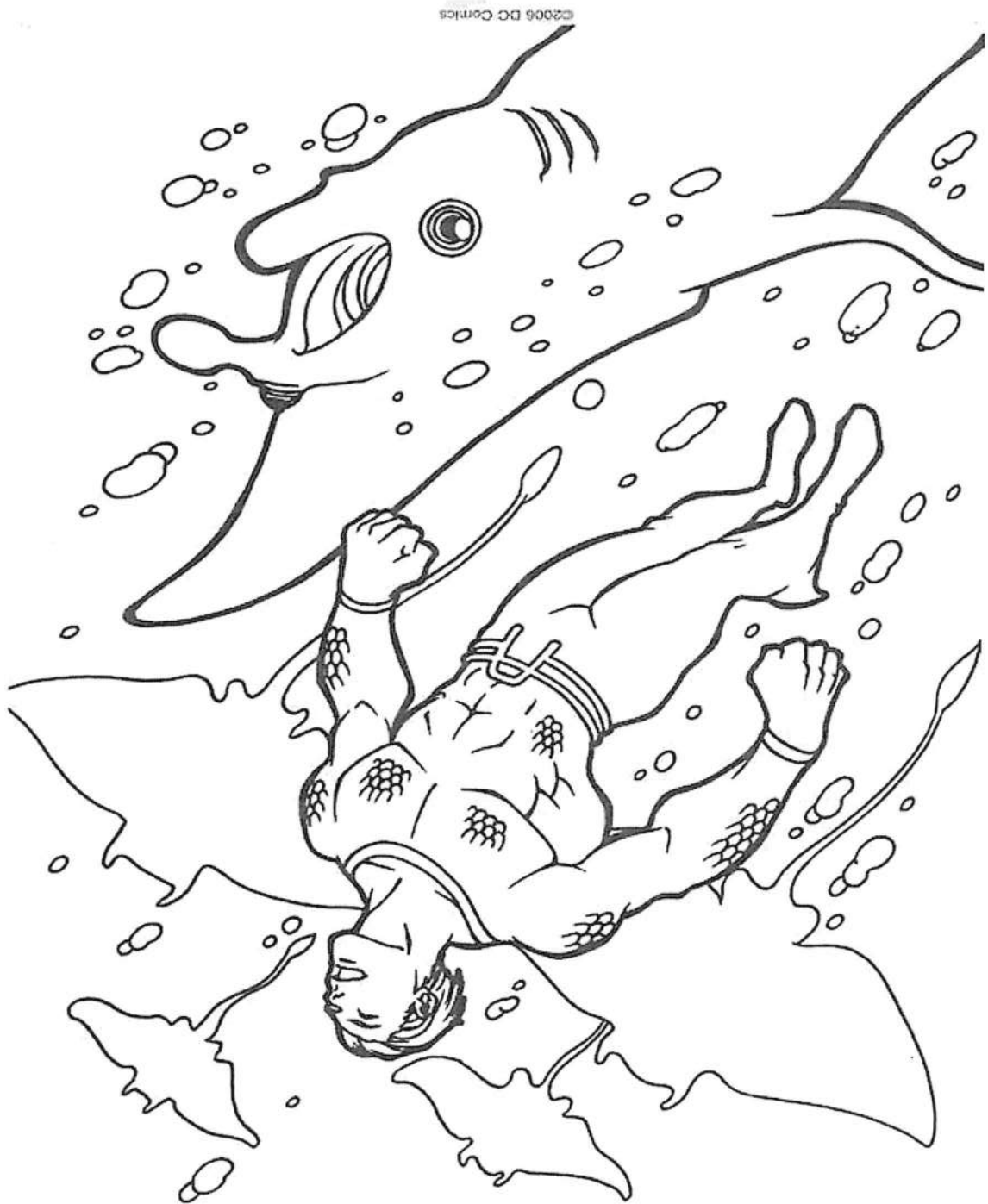

©2006 DC Comics



ISPY

Unicorns

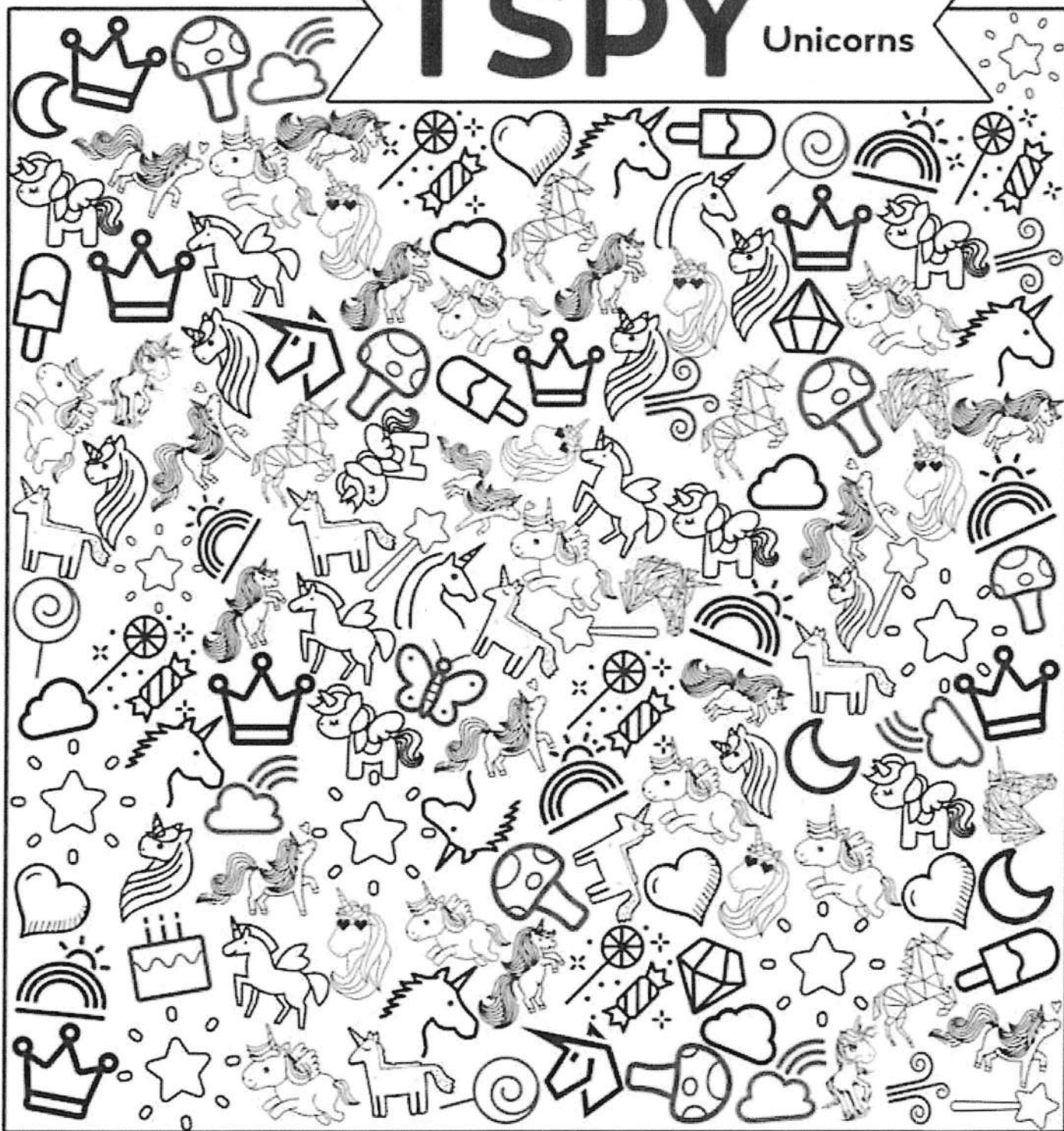

- | | | | | | | | | | | | | | | | | | | | |
|---|--|---|--|---|--|---|--|---|--|---|--|---|--|---|--|---|--|---|--|
| 2 | | 4 | | 4 | | 2 | | 4 | | 5 | | 7 | | 4 | | 6 | | 5 | |
| 1 | | 2 | | 7 | | 1 | | 3 | | 6 | | 7 | | 4 | | 7 | | 4 | |
| 3 | | 6 | | 4 | | 6 | | 2 | | 7 | | 3 | | 9 | | 6 | | 3 | |

ISPY

Unicorns



- | | | | | | | | | | | | | | | | | | | | |
|---|--|---|--|---|--|---|--|---|--|---|--|---|--|---|--|---|--|---|--|
| 2 | | 4 | | 4 | | 2 | | 4 | | 5 | | 7 | | 4 | | 6 | | 5 | |
| 1 | | 2 | | 7 | | 1 | | 3 | | 6 | | 7 | | 4 | | 7 | | 4 | |
| 3 | | 6 | | 4 | | 6 | | 2 | | 7 | | 3 | | 9 | | 6 | | 3 | |



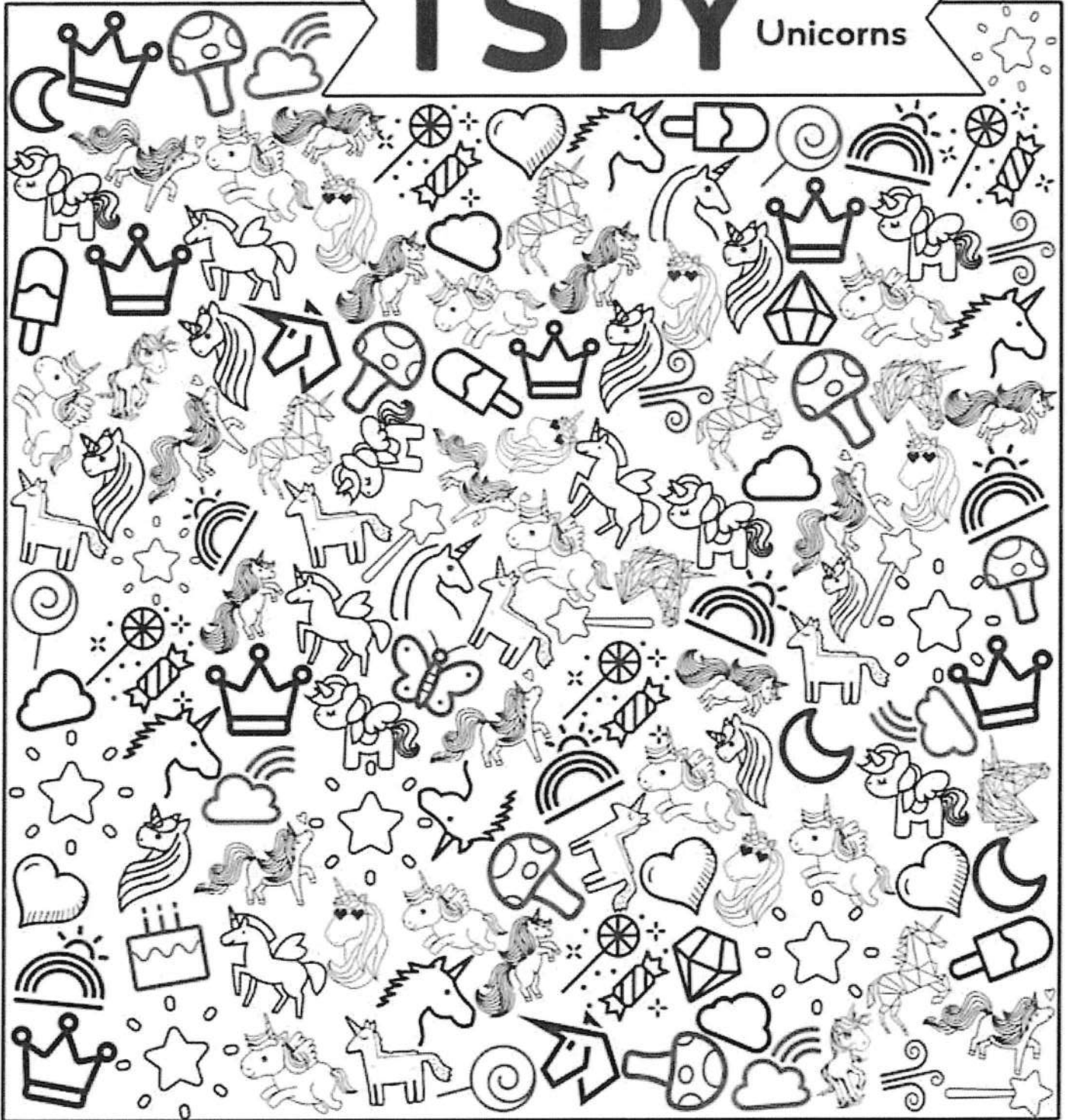





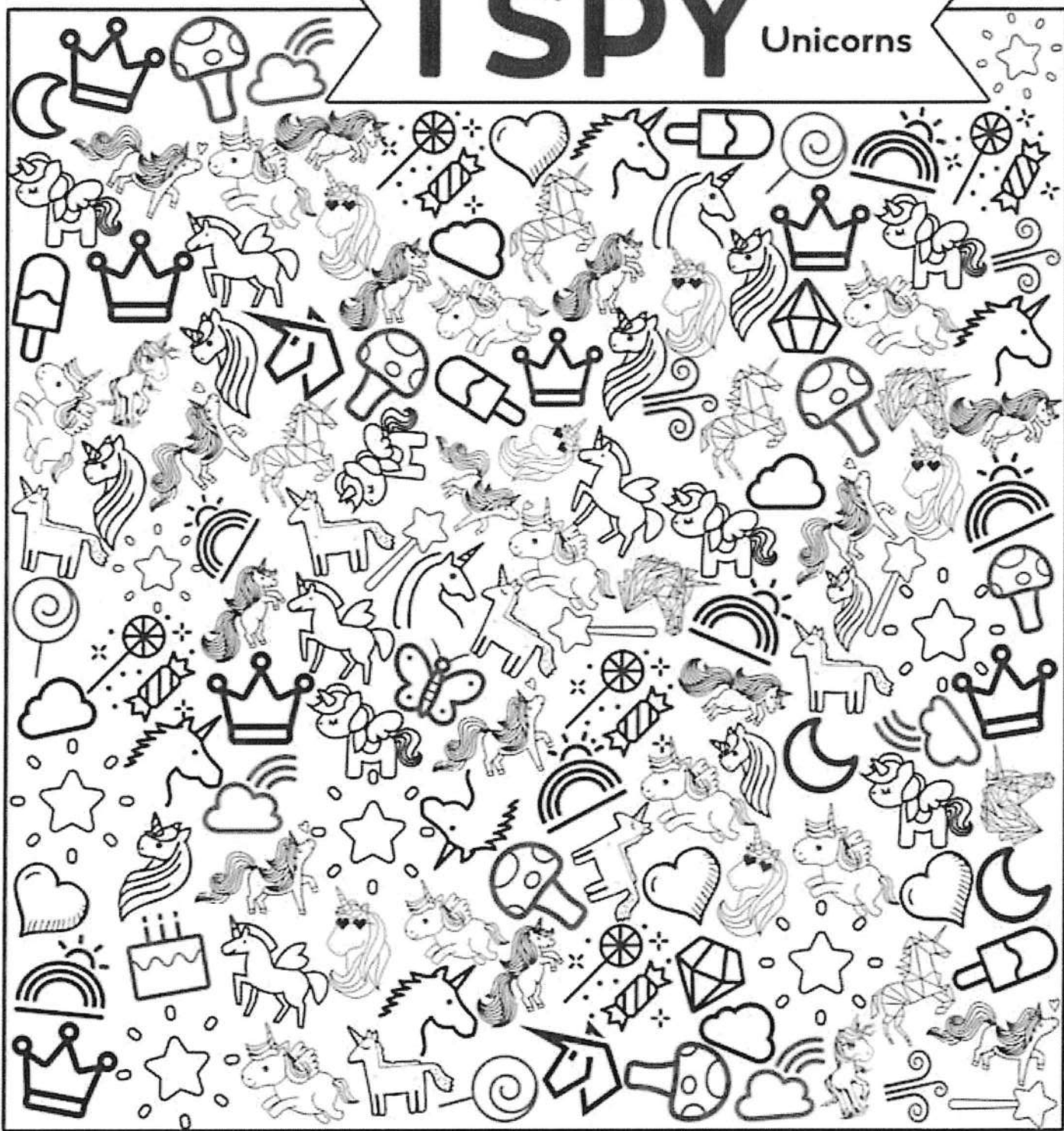





















ISPY Unicorns



- | | | | | | | | | | | | | | | | | | | | |
|---|--|---|--|---|--|---|--|---|--|---|--|---|--|---|--|---|--|---|--|
| 2 | | 4 | | 4 | | 2 | | 4 | | 5 | | 7 | | 4 | | 6 | | 5 | |
| 1 | | 2 | | 7 | | 1 | | 3 | | 6 | | 7 | | 4 | | 7 | | 4 | |
| 3 | | 6 | | 4 | | 6 | | 2 | | 7 | | 3 | | 9 | | 6 | | 3 | |

ISPY Unicorns



- | | | | | | | | | | |
|---|---|---|---|---|---|--|---|---|---|
| 2  | 4  | 4  | 2  | 4  | 5  | 7  | 4  | 6  | 5  |
| 1  | 2  | 7  | 1  | 3  | 6  | 7  | 4  | 7  | 4  |
| 3  | 6  | 4  | 6  | 2  | 7  | 3  | 9  | 6  | 3  |

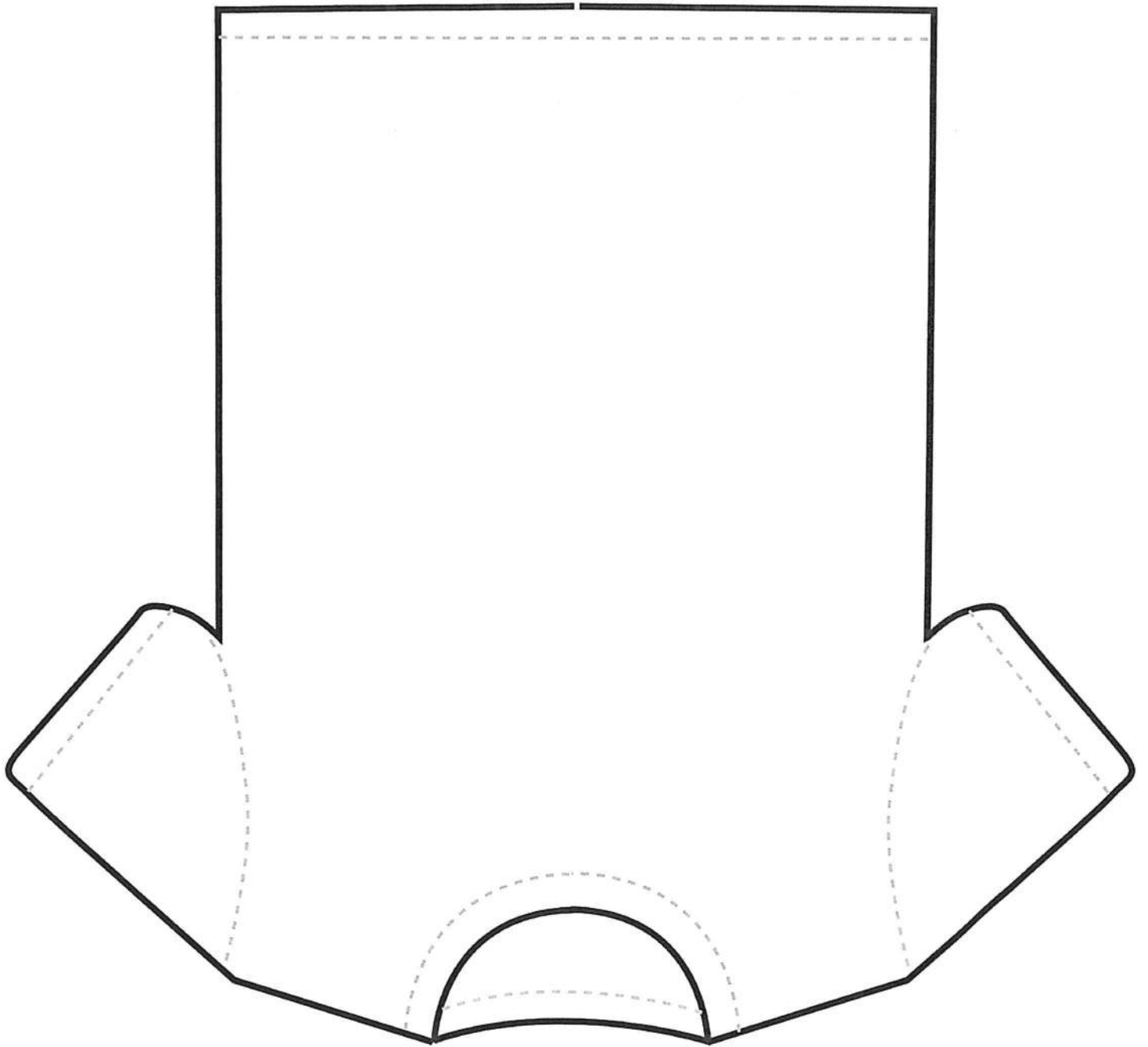

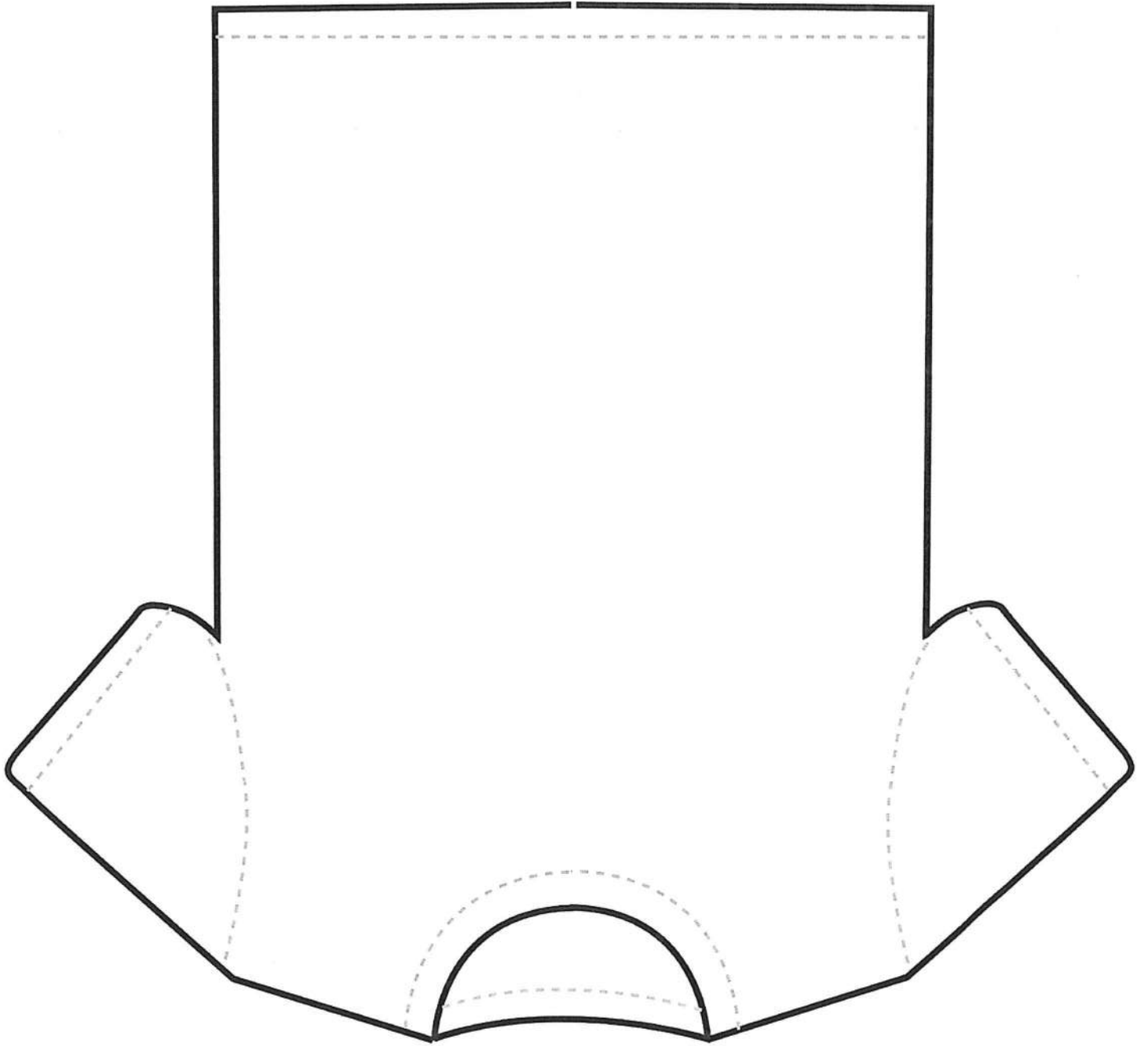

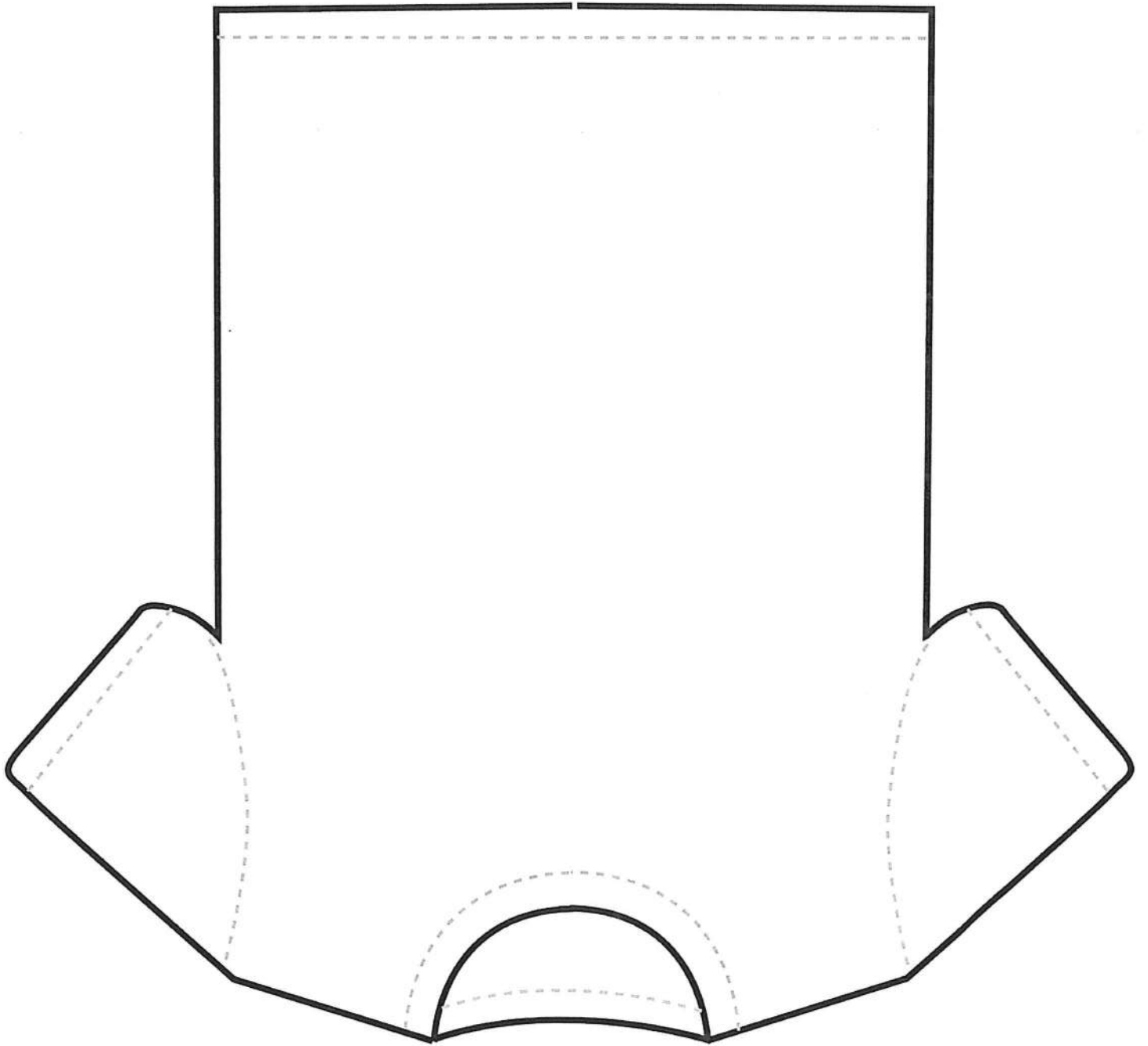

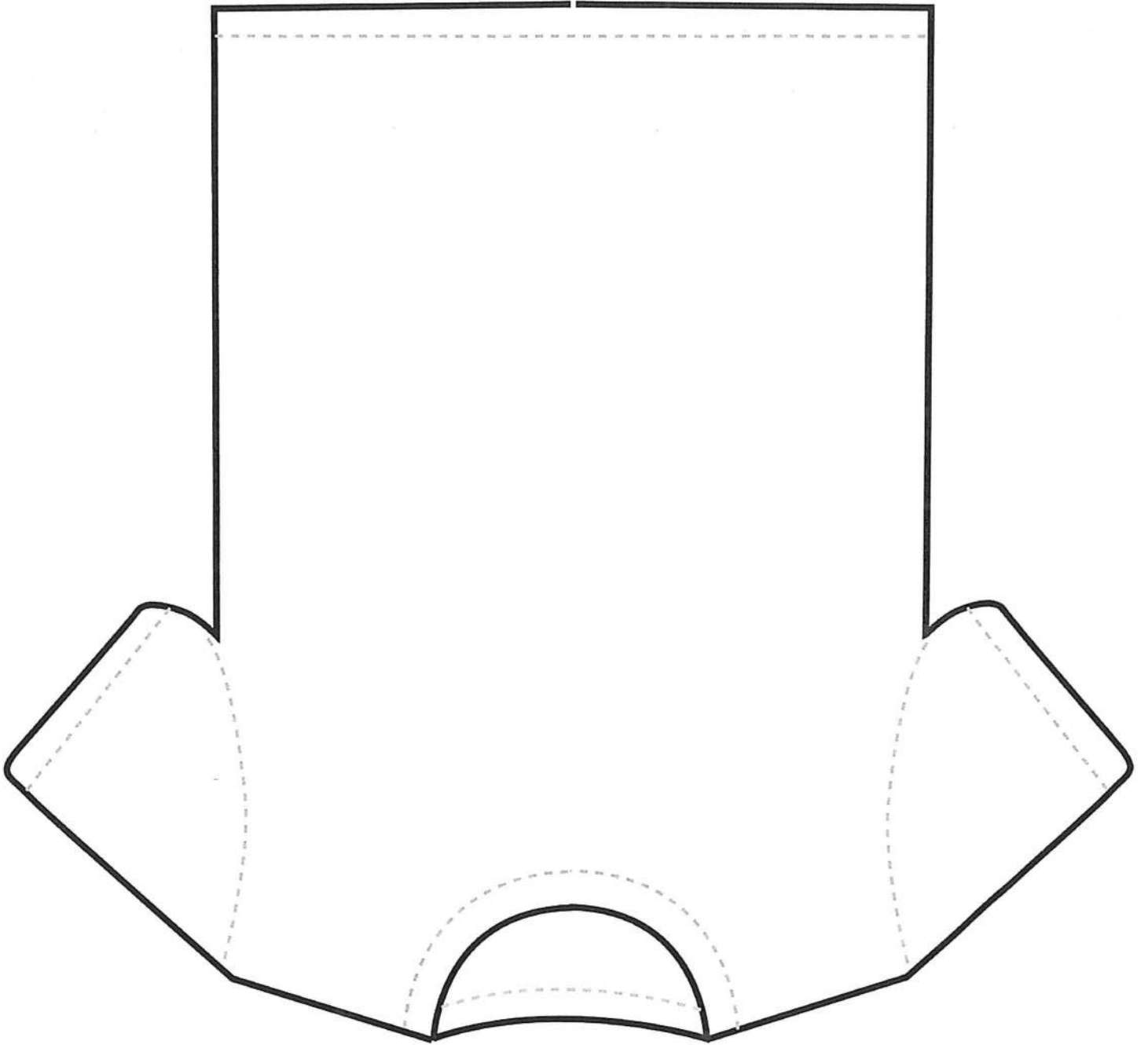

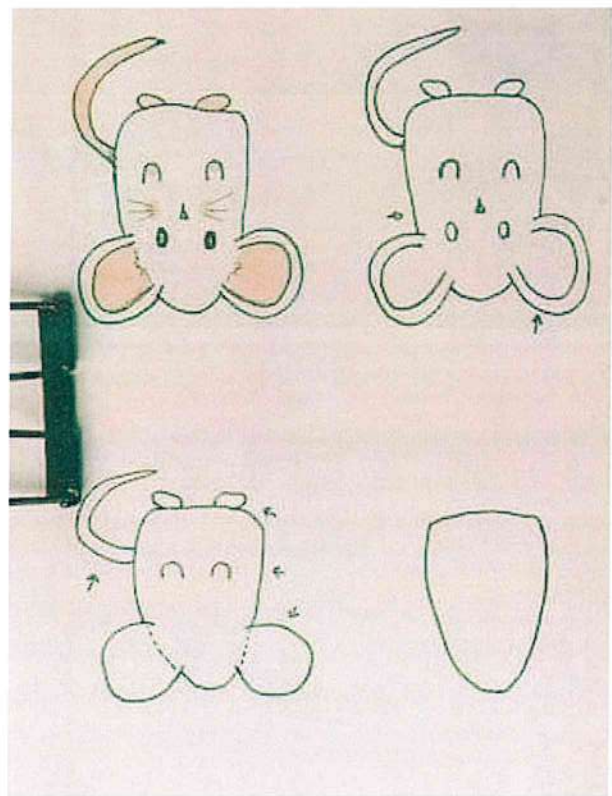
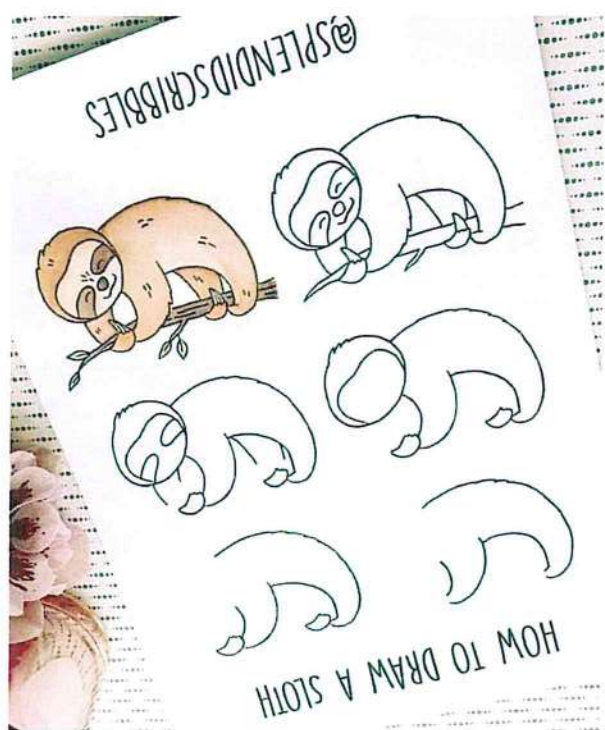
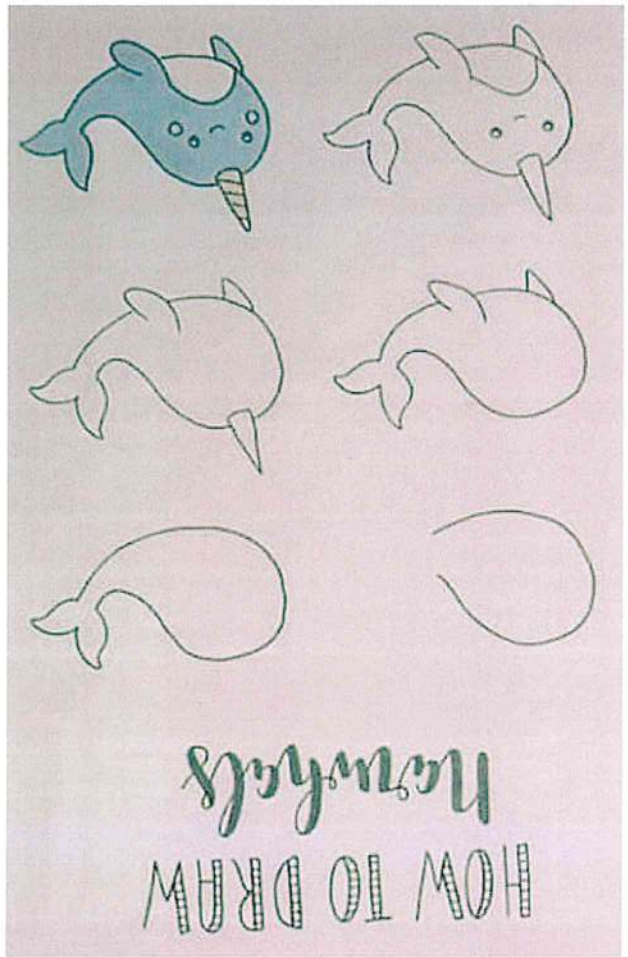
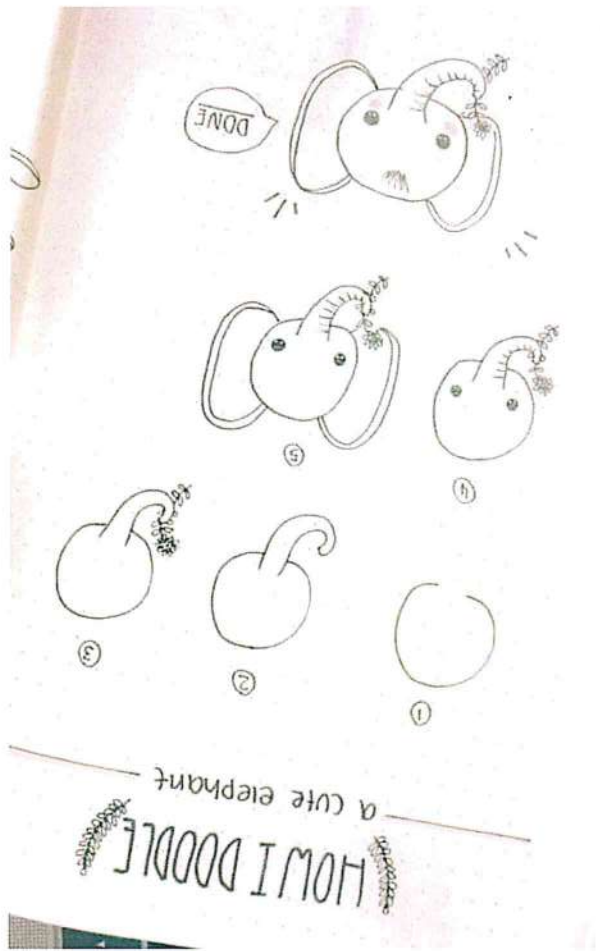



Nature Scavenger Hunt



- | | |
|---------------------------------------|--|
| <input type="checkbox"/> PINE CONE | <input type="checkbox"/> BIRD |
| <input type="checkbox"/> GREEN LEAF | <input type="checkbox"/> WATER |
| <input type="checkbox"/> BROWN LEAF | <input type="checkbox"/> CLOUD |
| <input type="checkbox"/> WILDFLOWER | <input type="checkbox"/> FLYING INSECT |
| <input type="checkbox"/> SPIDER WEB | <input type="checkbox"/> ROUND ROCK |
| <input type="checkbox"/> FEATHER | <input type="checkbox"/> COLORFUL ROCK |
| <input type="checkbox"/> BUG | <input type="checkbox"/> ROUGH OBJECT |
| <input type="checkbox"/> SEED | <input type="checkbox"/> SMOOTH OBJECT |
| <input type="checkbox"/> GRASS | <input type="checkbox"/> FALLEN BRANCH |
| <input type="checkbox"/> PINE NEEDLES | <input type="checkbox"/> TREASURE (TO YOU) |
- 

Nature Scavenger Hunt



- | | |
|---------------------------------------|--|
| <input type="checkbox"/> PINE CONE | <input type="checkbox"/> BIRD |
| <input type="checkbox"/> GREEN LEAF | <input type="checkbox"/> WATER |
| <input type="checkbox"/> BROWN LEAF | <input type="checkbox"/> CLOUD |
| <input type="checkbox"/> WILDFLOWER | <input type="checkbox"/> FLYING INSECT |
| <input type="checkbox"/> SPIDER WEB | <input type="checkbox"/> ROUND ROCK |
| <input type="checkbox"/> FEATHER | <input type="checkbox"/> COLORFUL ROCK |
| <input type="checkbox"/> BUG | <input type="checkbox"/> ROUGH OBJECT |
| <input type="checkbox"/> SEED | <input type="checkbox"/> SMOOTH OBJECT |
| <input type="checkbox"/> GRASS | <input type="checkbox"/> FALLEN BRANCH |
| <input type="checkbox"/> PINE NEEDLES | <input type="checkbox"/> TREASURE (TO YOU) |
- 



Nature Scavenger Hunt

© 2007 by Linda Ward Beech

- | | |
|---------------------------------------|--|
| <input type="checkbox"/> PINE CONE | <input type="checkbox"/> BIRD |
| <input type="checkbox"/> GREEN LEAF | <input type="checkbox"/> WATER |
| <input type="checkbox"/> BROWN LEAF | <input type="checkbox"/> CLOUD |
| <input type="checkbox"/> WILDFLOWER | <input type="checkbox"/> FLYING INSECT |
| <input type="checkbox"/> SPIDER WEB | <input type="checkbox"/> ROUND ROCK |
| <input type="checkbox"/> FEATHER | <input type="checkbox"/> COLORFUL ROCK |
| <input type="checkbox"/> BUG | <input type="checkbox"/> ROUGH OBJECT |
| <input type="checkbox"/> SEED | <input type="checkbox"/> SMOOTH OBJECT |
| <input type="checkbox"/> GRASS | <input type="checkbox"/> FALLEN BRANCH |
| <input type="checkbox"/> PINE NEEDLES | <input type="checkbox"/> TREASURE (TO YOU) |



Nature Scavenger Hunt

© 2007 by Linda Ward Beech

- | | |
|---------------------------------------|--|
| <input type="checkbox"/> PINE CONE | <input type="checkbox"/> BIRD |
| <input type="checkbox"/> GREEN LEAF | <input type="checkbox"/> WATER |
| <input type="checkbox"/> BROWN LEAF | <input type="checkbox"/> CLOUD |
| <input type="checkbox"/> WILDFLOWER | <input type="checkbox"/> FLYING INSECT |
| <input type="checkbox"/> SPIDER WEB | <input type="checkbox"/> ROUND ROCK |
| <input type="checkbox"/> FEATHER | <input type="checkbox"/> COLORFUL ROCK |
| <input type="checkbox"/> BUG | <input type="checkbox"/> ROUGH OBJECT |
| <input type="checkbox"/> SEED | <input type="checkbox"/> SMOOTH OBJECT |
| <input type="checkbox"/> GRASS | <input type="checkbox"/> FALLEN BRANCH |
| <input type="checkbox"/> PINE NEEDLES | <input type="checkbox"/> TREASURE (TO YOU) |





Find these foot prints..

		meerkat
		komodo dragon
		giraffe
		lion
		rhinoceros
		flamingo
		elephant
		poison dart frog
		wolf
		chimpanzee



Find these foot prints...

meerkat





© 2019 Little Owl's Resources

komodo dragon





© 2019 Little Owl's Resources

giraffe





© 2019 Little Owl's Resources

lion





© 2019 Little Owl's Resources

rhinoceros





© 2019 Little Owl's Resources

flamingo





© 2019 Little Owl's Resources

elephant





© 2019 Little Owl's Resources

poison dart frog





© 2019 Little Owl's Resources

wolf



© 2019 Little Owl's Resources

chimpanzee



© 2019 Little Owl's Resources

Find these foot prints...

meerkat

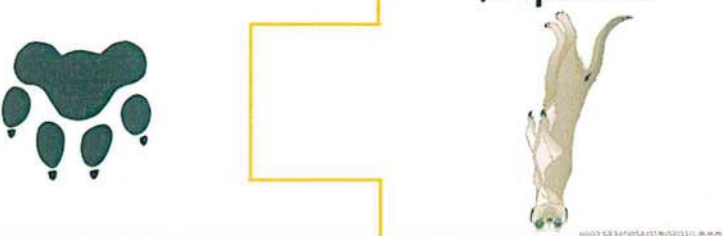

A meerkat footprint with five distinct pads. To its right is an illustration of a meerkat standing on its hind legs, facing left.

komodo dragon

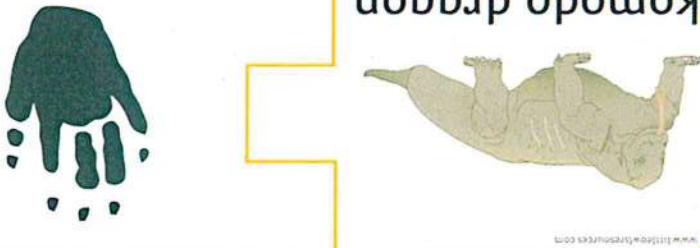

A large, hand-shaped footprint with five long, pointed pads. To its right is an illustration of a komodo dragon lying on its side, facing left.

giraffe



A footprint with two large, heart-shaped pads. To its right is an illustration of a giraffe standing, facing left.

lion

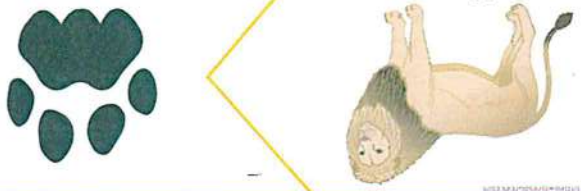

A footprint with five pads, including a large central pad. To its right is an illustration of a lion lying on its side, facing left.

rhinoceros

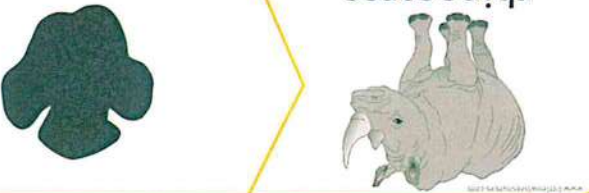

A footprint with three large, rounded pads. To its right is an illustration of a rhinoceros standing, facing left.

flamingo



A footprint with three long, narrow pads. To its right is an illustration of a flamingo standing, facing left.

elephant



A large, circular footprint. To its right is an illustration of an elephant standing, facing left.

poison dart frog



A footprint with five long, thin pads. To its right is an illustration of a blue and green poison dart frog.

wolf

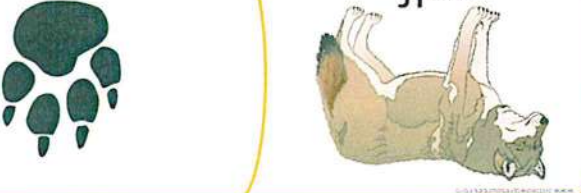

A footprint with five pads, including a large central pad. To its right is an illustration of a wolf standing, facing left.

chimpanzee



A footprint with five pads, including a large central pad. To its right is an illustration of a chimpanzee standing, facing left.



